

Varenummer: 2303039111  
Beskrivelse: E+G Fast Spændegreb  
MF.63 B-M8

## Mål

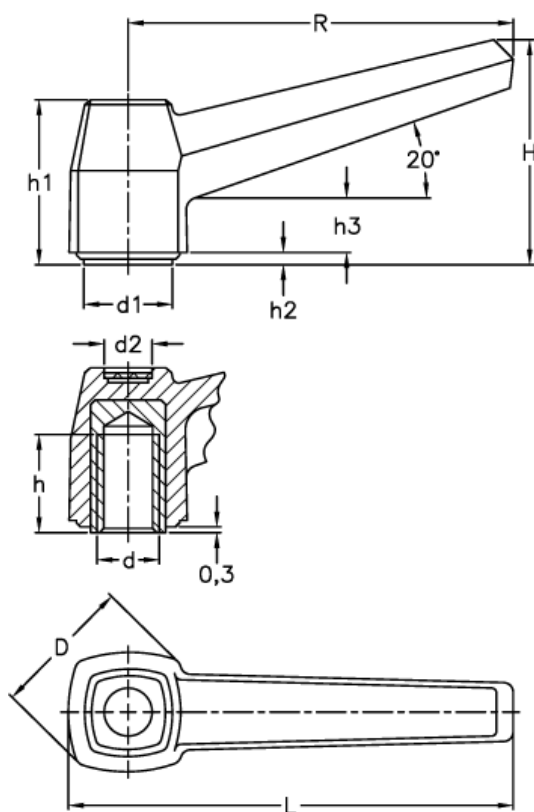

D	= 23	h3	= 11
d1	= 14.5	L	= 73
d2	= 9	R	= 63
d 6H	= M8		
h	= 13		
H	= 37		
h1	= 27		
h2	= 2.0		